

50-27 SIGNS.

50-27.1 Permit required.

- A. All signs that require a permit, as described in Section 50-27.7, must obtain a zoning permit as described in Section 50-37.13 (*Zoning permit*) of this Unified Development Chapter;
- B. When submitting a zoning permit application for a sign, the applicant must submit photographs and dimensions of all signs existing on the lot, including all signs that will be removed. The city may request that the applicant submit photographs of all new signs erected on the lot after permit issuance;
- C. The applicant must sign the zoning permit application attesting to the accuracy of the information provided. The city may revoke any sign permit where there has been a violation of the provisions of this section or misrepresentation of fact on the zoning permit application;
- D. All freestanding signs over seven feet in height must submit construction plans prepared by a design professional licensed in Minnesota that comply with the requirements of the Minnesota State Building Code. (Ord. No. 10044, 8-16-2010, § 6; Ord. No. 10047, 8-30-2010, § 1; Ord. No. 10204, 3-11-2013, § 1; cited only by Ord. No. 10222, 5-13-2013, § 1; Ord. No. 10338, 11-24-2014, § 1.)

50-27.2 Enforcement.

- A. No sign permit shall be required for the types of signs shown in Table 50-27-1, but each such sign shall be required to comply with the provisions of this Section 50-27. Any sign placed on public property or within a public right-of-way or public easement without authorization or without a required sign permit can be removed without notice. Such signs will be held by the city for 30 days. The owner of the sign may reclaim the sign within such period, subject to any fines imposed by the city. If not reclaimed, the city may destroy the sign following expiration of the 30 day period;
- B. If a sign is constructed illegally, either without a required permit or in violation of this section or previous sign regulations, the city may serve notice to the property owner that such sign must be removed or the violation corrected within 30 days. If the sign is not removed or the violation corrected within the 30 day period, the city may remove the sign at the property owner's expense. An extension of this 30 day period may be granted per Section 50-37.1.O (*Appeals*) of this Chapter, and must be applied for prior to expiration of the initial 30 day period. (Ord. No. 10044, 8-16-2010, § 6; Ord. No. 10204, 3/11/2013, § 1; cited only by Ord. No. 10222, 5-13-2013, § 1.)

50-27.3 Design and construction standards.

All signs constructed, erected, modified or altered must comply with the provisions of this Section and the requirements of the City Code.

A. Prohibited sign location.

1. No sign may be erected in a location that violates the Minnesota State Building Code, Minnesota State Fire Code or other regulations;
2. No sign, other than that placed by agencies of government or a sign whose placement is authorized by this Section or the city, may be erected in the public right-of-way or on public property;
3. Signs located on public right-of-ways or on/in public or private skywalks must comply with Chapter 44A of the City Charter;
4. No sign may be erected on private property without prior consent of the property owner;
5. No sign may be erected in violation of the view obstruction provisions of Section 50-25.2.M (*Protection of site distance*) with the exception of a freestanding pole sign, if permitted in the district, with a diameter no greater than one foot and where the sign face is mounted a minimum of eight feet above grade. No sign can be erected that obstructs free and clear vision of any street, intersection, parking lot ingress or egress, or driveway;
6. No sign may be erected in a manner that obstructs access to fire escapes, any ingress or egress,

or standpipes;

7. No sign may be erected on the exterior of a building to cover any windows or doors;
8. Signs on lots adjacent to state or county highways shall conform to the respective setbacks and other standards of the state and county highway departments;
9. Freestanding monument signs shall not be located closer than three feet from the lot line;
10. The supporting pole of a freestanding pole sign shall be setback from the lot line a minimum of three feet, but the sign itself may be up to the lot line. No part of a freestanding pole sign may encroach on a public right-of-way;

B. Sign dimension measurement methodology.

1. General measurement of sign area. Sign area is measured as follows:

- (a) For signs on a background, the entire area of the framework or background of the sign is calculated as sign area, including any material or color forming the sign face or background used to differentiate the sign from the structure against which it is placed. Sign area does not include any supports or bracing, unless such framework or bracing is part of the message or sign face;
- (b) For signs consisting of freestanding letters or logos, the sign area is calculated as the total area of each square, circle, rectangle or triangle, or combination thereof, that encompasses each individual letter or logo. Sign area does not include any supporting framework or bracing, unless such framework or bracing is part of the message or sign face;
- (c) For awning and canopy signs, the sign area is the printed area of the awning or canopy, calculated as the total area of each square, circle, rectangle or triangle, or combination thereof, that encompasses each individual letter or logo;
- (d) Window signs printed on a transparent film and affixed to the interior or exterior of a windowpane are calculated as individual letters or logos, provided that the portion of the transparent film around the perimeter of the individual letters or logos maintains 100 percent transparency of the window. Transparency is defined as both the ability to view into the interior of the establishment from the outside and to view the outside from the interior of the establishment through the same area;
- (e) The sign area of a three-dimensional,

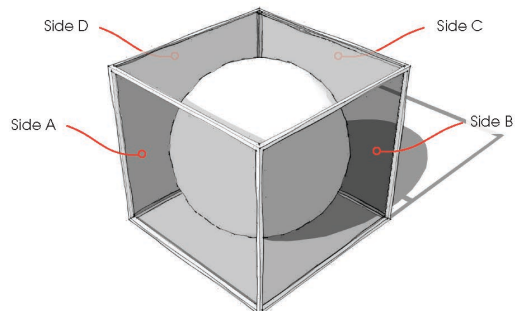
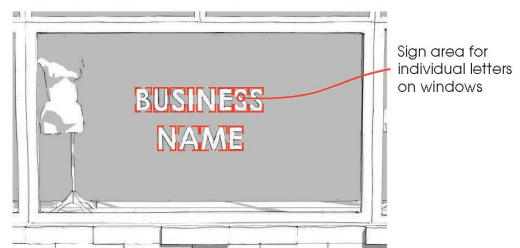
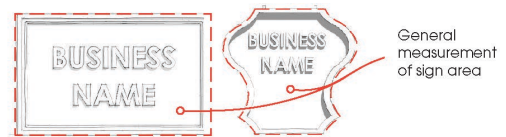

free-form or sculptural (non-planar) sign is calculated as 50 percent of the sum of the area of the four vertical sides of the smallest cube that will encompass the sign;

- (f) If a sign has two or more faces, the area of all faces is included in determining the area of the sign, unless the two sign faces are placed back-to-back and are no more than two feet apart. In such case, the sign area is calculated as the area of one face. If the two faces are unequal in area, the area of the larger face is used to calculate sign area;
 - (g) Necessary supports or uprights on which the sign is erected are not included in the sign area computation.
2. General measurement of sign height.
 - (a) Pole sign height is measured from the grade to the uppermost point of the sign. Grade is established by the elevation of the back of curb or, if no curb exists, from the edge of pavement at the center of the abutting street frontage where the sign will be erected. The pole sign height may also be measured from the natural slope of the lot where the sign will be erected;
 - (b) Monument sign height is measured from the existing lowest point of the ground where the monument sign is to be installed to the uppermost point of a sign;

C. Construction standards.

1. Supports and braces must be designed as an integral part of the overall sign design and hidden from public view to the extent technically feasible;
2. All signs attached to a building must be installed and maintained so that wall penetrations are watertight and the structure does not exceed allowable stresses of supporting materials;
3. All signs must be designed and constructed in accordance with Minnesota State Building and Fire codes. Marquee structures must be approved by the city engineer and building safety department;
4. Glass forming any part of a sign must be safety glass;
5. All letters, figures, characters or representations in cut-out or irregular form, maintained in conjunction with, attached to or superimposed upon any sign must be safely and securely built into or attached to the sign structure;
6. Audio components are prohibited on any sign, with the exception of menuboards;
7. Any form of pyrotechnics is prohibited;

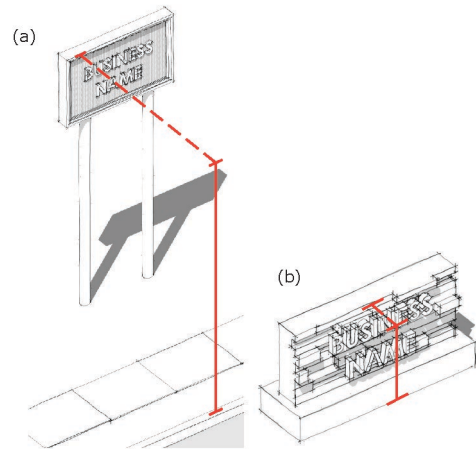

D. Electrical wiring.

1. All electrical fixtures, devices, circuits, conduits, raceways or apparatus used to illuminate, move or project any sign must be installed and maintained in accordance with Minnesota State Building Code, including the National Electrical Code. Electrical permits are required for sign installation in accordance with the Minnesota State Building Code;
2. Conduits and other components of a sign illumination system must be designed as an integral part of the overall sign structure and hidden from public view to the extent technically feasible;

E. Permit identification.

Every sign must include an identification of the permit number and name of sign installer either painted on the sign or by the application of a metallic sticker. The information must be visible from the ground with the exception of signs mounted seven or more feet above grade;

F. Required landscaping.

All freestanding signs, except in lots zoned I-G and I-W, must be landscaped at the base of the sign in accordance with the following:

1. Freestanding signs must be landscaped with small shrubs a minimum of 18 inches in height at planting, spaced appropriately based on mature height and spread to provide continuous screening of sign base once shrubs have reached maturity. The remainder of the landscape area must be planted with perennials, turf or other live groundcover;
2. Landscape must extend a minimum of two feet from the sign base on all sides. If this two foot area extends into the right-of-way, landscape is not required within the right-of-way area. All landscape must be maintained in good condition, and free and clear of rubbish and weeds. Landscape around the base of a sign is included in the total amount of landscape required on a site, if applicable;
3. There is no requirement regarding the mature height of landscape, though landscape must be tailored to the scale of the sign. Landscape may be trimmed and maintained along the sign base to maintain visibility of the sign face;
4. When a monument sign is designed as a single structure where the pediment is constructed of similar or complimentary materials as the sign, and no structural elements that are not related to such overall design of the sign are visible, no landscape is required;

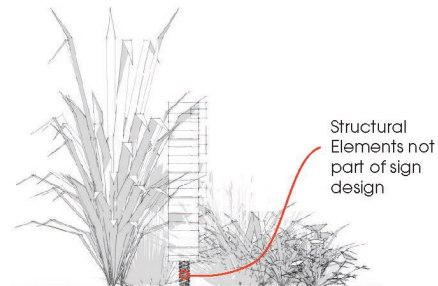

G. Required sign maintenance.

1. All signs must be maintained in a safe, neat and orderly condition and appearance, and must be repainted or otherwise maintained by the property owner to prevent corrosion or deterioration caused by the weather, age or any other condition;
2. All signs must be maintained to prevent any kind of safety hazard, including faulty sign structures, a fire hazard or an electrical shock hazard;
3. All unused sign hardware or wiring that is visible from the right-of-way must be removed;
4. If a sign is maintained in an unsafe or insecure condition, the city will give written notice to the property owner. If property owner fails to remove or alter the structure to comply with the standards of this Section, the sign may be removed by city at the expense of the property owner. The city may remove any sign that is an immediate peril to persons or property summarily and without notice;

H. Noncommercial messages.

A noncommercial message may be substituted for a commercial message on any sign permitted by this Section.

I. Permit identification.

All architectural signs on a structure announcing the original or historic name of the building, year of construction, or insignias must be maintained, and cannot be removed, altered, or covered. Such signs are not calculated as part of any sign area or maximum number of signs permitted by this Section. (Ord. No. 10044, 8-16-2010, § 6; Ord. No. 10047, 8-30-2010, § 2; Ord. No. 10204, 3-11-2013, § 1; cited only by Ord. No. 10222, 5-13-2013, § 1.)

50-27.4 Illumination standards.

The following illumination standards apply to on-premises signs. Illumination of billboards (off-premises) are regulated separately in Section 50-27.7. Additional illumination requirements for electronic message signs are found in Section 50-27.7.

- A. Any sign illumination, including gooseneck reflectors, external illumination and internal illumination, must be designed, located, shielded and directed to prevent the casting of glare or direct light upon roadways and surrounding properties, or the distraction of motor vehicle operators or pedestrians in the public right-of-way;
- B. The sign face of internally illuminated signs must function as a filter to diffuse illumination. The sign face must cover all internal illumination components so that no exposed bulbs are visible;
- C. All external illumination of a sign must concentrate the illumination upon the printed area of the sign face;
- D. No sign illumination may exceed one footcandle of illumination at the property line;
- E. The use of neon lighting as a sign material or sign accent is permitted for signs within the mixed-use, form-based and special purpose districts, with the exception of the MU-N and MU-B districts where it is prohibited. Neon lighting is subject to the following:
 1. When lit, neon lighting must be continuously illuminated. Flashing neon is prohibited;
 2. Neon lighting cannot be combined with any reflective materials (e.g., mirrors, polished metal, highly-glazed tiles, or other similar materials) that would cause glare and increase the spread of light;
 3. Neon lighting to outline doors and windows is prohibited;
- F. The use of LED lighting as a sign accent is permitted, subject to the following:
 1. LED lighting as an accent is only permitted for non-residential uses in the mixed-use, form-based and special purpose districts where electronic message center signs are permitted. LED accent lighting is prohibited in any residential district;
 2. LED lighting as an accent must comply with all illumination requirements of an electronic message center sign;
 3. The addition of LED lighting as an accent to an existing sign requires a zoning permit;
 4. When lit, LED lighting must be continuously illuminated. Flashing LED is prohibited;
 5. LED lighting cannot be combined with any reflective materials (e.g., mirrors, polished metal, highly-glazed tiles, or other similar materials) that would cause glare and increase the spread of light;
 6. LED lighting to billboards, free standing monument signs, outline doors, windows, any part of a structure and automobile and filling station gas canopies is prohibited;
 7. LED lighting to outline free standing pole signs is allowed but lighting must conform to the same brightness standards as electronic message centers as identified in UDC Section 50-27.7.G. (Ord. No. 10044, 8-16-2010, § 6; Ord. No. 10047, 8-30-2010, § 3; Ord. No. 10204, 3-11-2013, § 1; cited only by Ord. No. 10222, 5-13-2013, § 1; Ord. No. 10338, 11-24-2014, § 2.)

50-27.5 Prohibited signs.

The following signs are prohibited:

- A. Balloon and air-infused/air-inflated signs;
- B. Electronic display screens;
- C. Flashing or animated signs;
- D. Illegally-affixed signs;
- E. Moving signs, including signs moved by wind or mechanical or electrical components. No sign or part of any sign shall move or give the illusion of movement in any manner. Clocks and barber poles are exempt from this provision;
- F. Portable signs. Portable signs include both signs mounted on a wheeled structure and those mounted on a stationary structure that can be moved and is not permanently installed on a site;
- G. Roof signs;
- H. Snipe signs;
- I. Strobe lights, moving or fixed spotlights, and floodlights;
- J. Temporary off-premises signs;
- K. Traffic hazard signs. Any sign that constitutes a traffic hazard is prohibited, including signs that:
 - 1. Interfere with, obstruct the view of, or may be confused with any authorized traffic sign, signal or device because of its position, shape or color, including signs illuminated in red, green or amber color to resemble a traffic signal;
 - 2. Make use of the words STOP, LOOK, DETOUR, DANGER, CAUTION, WARNING or any other word, phrase, symbol or character in a manner that misleads, interferes with or confuses traffic;
- L. Vehicle signs. Signs placed or painted on parked vehicles where the primary purpose is to advertise a product or service, or to direct the public to a business or activity located on or off the premises, are prohibited. Signs painted on vehicles, trucks or buses, which are being operated and stored in the normal course of business, such as signs located on delivery trucks, promotional vehicles, moving vans and rental trucks, are permitted, provided that the primary purpose of such vehicles is not the display of signs, and that they are parked or stored in areas related to their use as vehicles. Vehicle for-sale signs are exempt from this provision. (Ord. No. 10041, 8-16-2010, § 7; Ord. No. 10044, 8-16-2010, § 6; Ord. No. 10047, 8-30-2010, § 9; Ord. No. 10096, 7-18-2011, § 38; Ord. No. 10204, 3-11-2-13, § 1; cited only by Ord. No. 10222, 5-13-2013, § 1.)

50-27.6 Signs and activities exempt from permit requirements.

A. Alternation and maintenance operations.

The following activities are exempt from a zoning permit:

- 1. Painting, repainting, cleaning, and/or other normal maintenance and repair of a sign, not involving structural alterations or changes in the electrical components of the sign. Repairs to existing permitted illumination components are also exempt from sign permit requirements;
- 2. Changing of the message of an existing changeable message sign or electronic message sign;
- 3. Changing the sign face within an existing legal sign structure, provided no alterations are made to the sign structure and the sign area, sign height or any other dimension of the sign;

B. Illumination.

No exempt sign may be illuminated, except for the following:

- 1. Uplighting of official federal, state, county or city flags;
- 2. Lighting of official federal, state, county or city government signs as needed by the government body;

C. Exempt permanent signs.

This Section describes the types of permanent signs that are allowed without a zoning permit. All exempt signs must comply with all the regulations of this section. Exempt permanent signs are subject to the regulations of Table 50-27-1: *Exempt Permanent Sign Regulations*.

TABLE 50-27-1: EXEMPT PERMANENT SIGN REGULATIONS						
SIGN	PERMITTED DISTRICT OR USE	PERMITTED SIGN TYPE	MAXIMUM SIZE	MAXIMUM HEIGHT (FREE-STANDING SIGNS)	REQUIRED SETBACK OR LOCATION (FREESTANDING SIGNS)	NUMBER PER LOT
Agricultural Identification Sign	All agricultural uses	Freestanding or wall	RC, RR-1, RR-2: 20sf All other districts: 6 sf	6'	20' from front lot line & 10' from any other lot line	1 per street frontage
Bed and Breakfast	Bed and breakfast uses	Freestanding or wall	12 sf	7'	5' from any lot line	1 per lot
Building Directory Sign	All multi-family & non-residential uses	Freestanding or wall	6 sf	7'	Within 10' of building entry	1 per building entry
Day Care Facility	Residential zone districts	Wall or non-illuminated lawn sign	6 sf	7'	5' from any lot line	1 per lot
Flags – Federal, State or Local	All districts and uses	Freestanding	No Limit	No limit	5' from any lot line	No limit
Flags – Commercial	All non-residential uses	Freestanding	16 sf	Flagpole limited to maximum height of zoning district	5' from any lot line	1 per lot
Government Information Sign (Federal, State, County or City)	All districts & uses	Freestanding or wall	No Limit	No Limit	No Limit	No Limit
Home Occupation Sign	All residential dwelling uses and permitted accessory uses	Wall, window or freestanding including mounting on private lightposts	4 sf	4'	5' from any lot line	1 per lot
Memorial Plaque	All districts and uses	Freestanding or wall	No limit	Limited to maximum height of zoning district	5' from any lot line	1 per lot
Nameplate	All districts and uses	Wall	4 sf	(Not Applicable)	(Not Applicable)	1 per lot
Parking Lot Directional Sign	All parking lots and structures	Freestanding	4 sf	7'	0' from any lot line	No limit
Parking Lot Information Sign	All parking lots and structures	Freestanding or wall	16 sf	12'	0' from any lot line	3 per access point
Property Identification Sign	All multi-family residential uses	Wall	4 sf	(Not Applicable)	(Not Applicable)	1 per lot

TABLE 50-27-1: EXEMPT PERMANENT SIGN REGULATIONS						
SIGN	PERMITTED DISTRICT OR USE	PERMITTED SIGN TYPE	MAXIMUM SIZE	MAXIMUM HEIGHT (FREE-STANDING SIGNS)	REQUIRED SETBACK OR LOCATION (FREESTANDING SIGNS)	NUMBER PER LOT
Public Information Sign	The following uses: All educational facilities; cemetery or mausoleum; museum, library or art gallery; park, playground or forest reserve	Freestanding or wall	No limit	No limit	No limit	No limit
Public Information School and Field Identification Sign	All districts. K-12 public and private schools. Only to identify name of school, recreation field, or athletic team.	Nonilluminated wall sign	No limit	No limit	No limit	No limit
Permanent Window Sign	All non-residential uses	Window	Temporary & permanent signs (combined) are limited to 30% coverage of each window	(Not applicable)	(Not applicable)	(Not applicable)
Time and Temperature Sign (Electronic)	All non-residential uses	Must be integrated into primary freestanding or wall sign	20% of sign area of free-standing or wall sign, or if stand-alone sign, 6 sf	(Not Applicable)	(Not Applicable)	1 per lot

D. Exempt temporary signs.

This Section describes the types of temporary signs that are allowed without a zoning permit. All exempt signs must comply with all the regulations of this Section.

1. Exempt temporary signs are subject to the display periods in Table 50-27-2: *Permitted Display Period*.

TABLE 50-27-2: EXEMPT TEMPORARY SIGN PERMITTED DISPLAY PERIOD	
SIGN	PERMITTED DISPLAY PERIOD
Attention-Getting Device	When related to a time-specific event: Combined display period of 14 days prior to the event, the time period of the event and 2 days following the event When not related to a time-specific event: 10 days Limited to no more than 4 display periods in a year, with a minimum of 30 days between displays
Banner (General)	When related to a time-specific event: Combined display period of 14 days prior to the event, the time period of the event and 2 days following the event When not related to a time-specific event: 30 days Limited to no more than 4 display periods in a year, with a minimum of 30 days between displays
Community Event Sign	Limited to no more than 4 display periods in a year for a total aggregate display time of 20 days per year

Construction Sign	Erected only after approval of a building permit and must be removed within 7 days of issuance of an occupancy permit or completion of construction, whichever occurs first
Non-Commercial Message Sign	General: No display period limitation Election: Signs of any size related to an election or referendum may be posted in any number from 46 days before the state primary in a state general election year until 10 days following the state general election
Real Estate Sign	All real estate signs may only be erected on the specific property offered for sale or lease or the property holding an open house Real estate for sale/lease signs: Posted for the duration the property is offered for sale or lease, and must be removed within 7 days of closing or lease Real estate open house signs: Only during the day of the open house and must be removed within 2 hours of the end of the event
Temporary Window Sign	Limited to no more than 4 display periods in a year for a total aggregate display time of 60 days per year

2. Exempt temporary signs are subject to the regulations of Table 50-27-3: *Exempt Temporary Sign Regulations*.

TABLE 50-27-3: EXEMPT TEMPORARY SIGN REGULATIONS						
SIGN	PERMITTED DISTRICT OR USE	PERMITTED SIGN TYPE	MAXIMUM SIZE	MAXIMUM HEIGHT (FREESTANDING SIGNS)	REQUIRED SETBACK OR LOCATION (FREESTANDING SIGNS)	NUMBER PER LOT
Attention-Getting Device	Nonresidential uses in MU-C	Freestanding	10 sf	6'	10' from any lot line	1 per lot
Banner (general)	Non-residential uses	Wall or retaining wall	32 sf	(Not applicable)	(Not applicable)	1 per lot
Community Event Sign	All districts and uses	Freestanding or wall	10 sf	6'	10' from any lot line	1 per lot
Construction Sign	All districts and uses	Freestanding or wall	50 sf	6'	10' from any lot line	50 sf total per street frontage
Non-Commercial Message Sign, Election	All districts and uses	Freestanding, wall or retaining wall	No limit	No limit	No limit	No limit
Non-Commercial Message Sign, General	All districts and uses	Freestanding, wall or retaining wall	64 sf	6'	No limit	1 per street frontage
Real Estate Sign	All districts and uses	Freestanding or wall	Residential Districts: 4 sf All Other Districts: 12 sf	5'	10' from any lot line	1 per street frontage
Temporary Window Sign	All nonresidential uses	Window	Temporary & permanent signs (combined) are limited to 30% coverage of each window	(Not applicable)	(Not applicable)	(Not applicable)

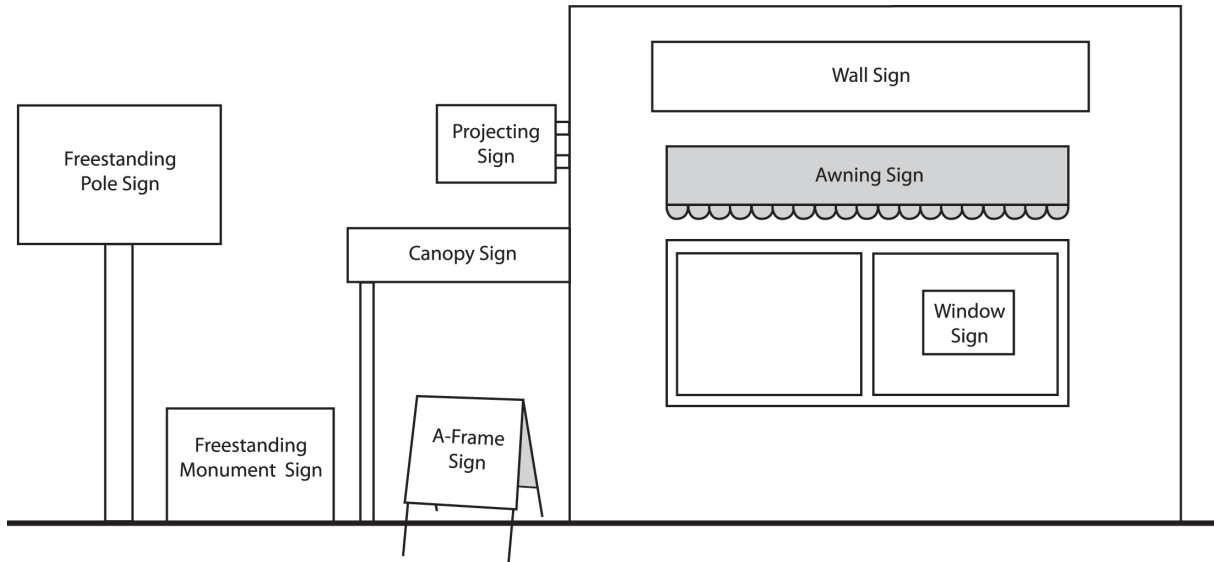

Figure 50-27.6-A: Examples of Common Sign Types.

(Ord. No. 10044, 8-16-2010, § 6; Ord. No. 10204, 3-11-2013, § 1; Ord. No. 10222, 5-13-2013, § 1; Ord. No. 10286, 3-10-2014, §14.)

50-27.7 Sign types.

A. General regulation.

The following types of signs require a zoning permit before they can be erected on a site. Table 50-27-4: Sign Types – Permit Required: District and Use Permissions describes which sign types are permitted in each district. In many districts, multiple sign types for the same development may be permitted.

TABLE 50-27-4: SIGN TYPES – PERMIT REQUIRED: DISTRICT AND USE PERMISSIONS																									
KEY (REFERENCE TABLE 50-19.8 FOR USES)																									
1 : Residential Uses											3: Commercial Uses														
1A: Multi-Family Dwelling Only											4: Industrial Uses														
2 : Public, Institutional and Civic Uses																									
<i>NOTE: Accessory uses are subject to the home occupation sign standards</i>																									
	R-C	RR-1	RR-2	R-1	R-2	R-P	MU-N	MU-C	MU-I	MU-B	MU-W	MU-P	F-1	F-2	F-3	F-4	F-5	F-6	F-7	F-8	F-9	I-G	I-W	P-1	
A-Frame Sign							3	3			3	3	3	3	3	3	3	3	3	3	3			2	
Awning	1A 2 3 4	1A 2 3 4	1A 2 3 4	1A 2 3 4	1A 2 3 4	1A 2 3 4	1A 2 3 4	1A 2 3 4	1A 2 3 4	1A 2 3 4	1A 2 3 4	1A 2 3 4	1A 2 3 4	1A 2 3 4	1A 2 3 4	1A 2 3 4	1A 2 3 4	1A 2 3 4	1A 2 3 4	1A 2 3 4	1A 2 3 4	1A 2 3 4	1A 2 3 4	2	
Banner - Exhibition	2	2	2	2	2	2	2	2	2	2	2	2	2	2	2	2	2	2	2	2	2	2	2	2	2
Billboard ¹								3 4		3 4		3 4										3 4			
Canopy	1A 2 3 4	1A 2 3 4	1A 2 3 4	1A 2 3 4	1A 2 3 4	1A 2 3 4	1A 2 3 4	1A 2 3 4	1A 2 3 4	1A 2 3 4	1A 2 3 4	1A 2 3 4	1A 2 3 4	1A 2 3 4	1A 2 3 4	1A 2 3 4	1A 2 3 4	1A 2 3 4	1A 2 3 4	1A 2 3 4	1A 2 3 4	1A 2 3 4	1A 2 3 4	2	
Electronic Message Sign ²	2	2	2	2	2	2	2	2 3 4	2 3 4	2 3 4	2	2 3 4	2	2	2	2	2	2	2 3	2 3 4	4	2	2	2	
Freestanding Signs – Pole	2	2	2	2	2	2	2 3 4	2 3 4	2 3 4	2	2 3 4	2 3 4	2 3 4	2 3 4	2 3 4	2 3 4	2 3 4	2 3 4	2 3 4	2 3 4	2 3 4	2 3 4	2 3 4	2	
Freestanding Signs – Monument	1 2	1 2	1 2	1 2	1 2	1 2	1 2 3 4	1 2 3 4	1 2 3 4	1 2 3 4	1 2 3 4	1 2 3 4	1 2 3 4	1 2 3 4	1 2 3 4	1 2 3 4	1 2 3 4	1 2 3 4	1 2 3 4	1 2 3 4	1 2 3 4	1 2 3 4	1 2 3 4	2	
Marquee							3 4	3 4			3 4	3 4					3 4	3 4	3 4						
Projecting Sign							3 4	3 4	3 4	3 4	3 4	3 4	3 4	3 4	3 4	3 4	3 4	3 4	3 4	3 4	3 4	3 4	3 4	3 4	
Scoreboard	2	2	2	2	2	2	2	2	2	2	2	2	2	2	2	2	2	2	2	2	2	2	2	2	2
Wall Sign	2 3 4	2 3 4	2 3 4	2 3 4	2 3 4	2 3 4	2 3 4	2 3 4	2 3 4	2 3 4	2 3 4	2 3 4	2 3 4	2 3 4	2 3 4	2 3 4	2 3 4	2 3 4	2 3 4	2 3 4	2 3 4	2 3 4	2 3 4	2	

¹ Billboards are permitted on any lot within the noted districts, whether developed or undeveloped, unless such lot is developed for a one-family or two-family dwelling.

² Filling station uses in any district are permitted to display fuel prices by an electronic message component, and are subject to the restrictions of that section.

Electronic message signs are not allowed in the Historic Canal Park area as identified in UDC Section 50-27.8.C.

Electronic message signs are allowed in the Entertainment District area as identified in UDC Section 50-27.8.B.

B. A-frame signs.

A-frame signs are permitted as indicated in Table 50-27-4, subject to the following regulations.

1. A-frame signs are limited to six square feet in area per side and four feet in height. The use of A-frame signs is limited to business hours only and may not be displayed for more than 16 hours in a 24 hour period. Signs must be stored indoors at all other times;
2. An A-frame sign must be placed on the property where the business is located and within ten feet of the primary entrance of the business or on the right-of-way in front of property. A-frame signs must provide an unobstructed sidewalk width of at least five feet for pedestrian passage and must not interfere with pedestrian traffic or violate standards of accessibility as required by the ADA or other accessibility codes;
3. The permit applicant must provide and maintain in force a certificate of insurance, in a form approved by the city, that evidences that the applicant has in force insurance in the minimum amounts required by the city for bodily injuries or property damage in any one year protecting such person or organization and the City against liability for injuries or damages resulting from the placement of such objects or materials in the public right-of-way. Proof of insurance must be renewed on an annual basis;

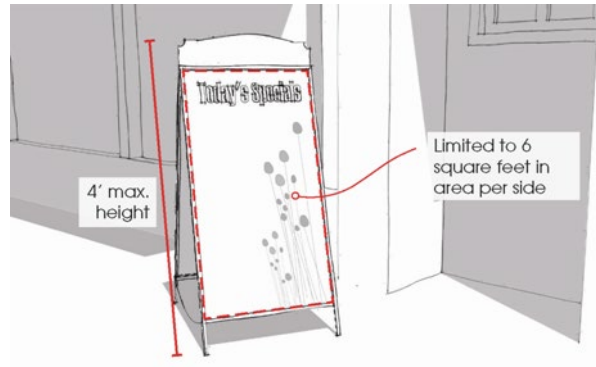

C. Awning.

Awnings without printing, with the exception of a street address number (number only), are considered an architectural feature and are not regulated by this Section. This Section regulates awning signs, which are used to identify a use by name or logo, the goods or services offered on-site, and similar sign information. Awning signs are permitted as indicated in Table 50-27-4, subject to the following regulations:

1. Awning signs must maintain a minimum vertical clearance of seven feet six inches (7' 6");
2. Awning signs must be located a minimum of 18 inches from the back of curb;
3. Awning signs must comply with Minnesota State Building and Fire codes, including provisions for encroachment into the public right-of-way, structural requirements, sprinkler protections and similar regulations;
4. Awning signs must be made of a durable, weather-resistant material like canvas, canvas-like material, nylon, vinyl-coated fabric or metal. Solid, flat-roofed awnings may also be made out of finished wood, wood and plastic composites, metal or metal cladding, stucco or EIFS;
5. Printing on any awning sign is limited to 30 percent of the surface area;
6. Awning signs are permitted lettering attached to and located above the top of a solid awning to a maximum height of 24 inches. Signs mounted to solid, flat roofed awnings are limited to individually-mounted letters with internal illumination (if illuminated) or a sign board with external illumination – no internally illuminated cabinet signs;
7. Awning signs may illuminate the printed area of the awning with gooseneck or similar external illumination. Back-lit awnings are prohibited;
8. Under-awning signs are permitted subject to the following:
 - (a) Under-awning signs must be attached to the underside of an awning. Under-awning signs must not project beyond the awning;
 - (b) Under-awning signs must maintain a minimum vertical clearance of seven feet;
 - (c) A maximum of one under-awning sign is permitted per business establishment with frontage on the street where the awning is mounted;
 - (d) Each under-awning sign is limited to a maximum of six square feet;
 - (e) Under-awning signs must be securely fixed to the awning with metal supports;
 - (f) Under-awning signs must be made of wood, metal or plastic;
9. A sign permit is required for recovering or resurfacing an existing awning;

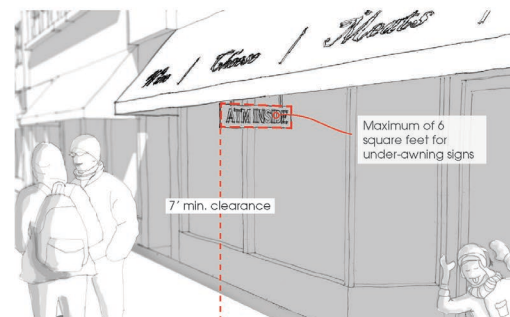
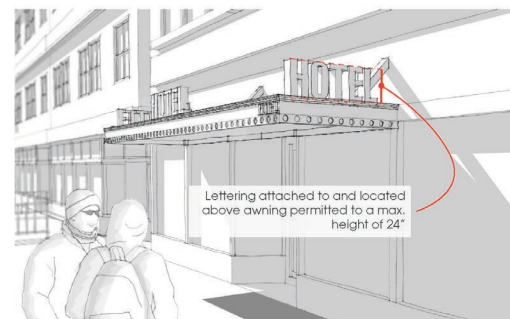
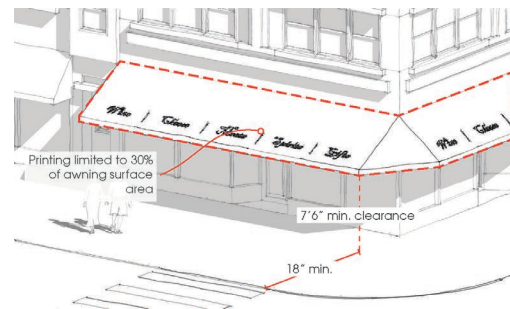

D. Exhibition banners.

Exhibition banners are intended to be used in conjunction with a special exhibit for an educational facility, government building, museum, library or art gallery, or religious assembly. Exhibition banners are permitted for events and exhibitions as indicated in Table 50-27-4, subject to the following regulations:

1. Each use is permitted up to six exhibition banners during one display period. The display period is defined as the combined period of 30 days prior to the opening of the exhibit, the run of the exhibit, and for 14 days following the close of the exhibit. In no event may the display of exhibition banners exceed four months in any calendar year;
2. Exhibition banners must be made of a durable, weather-resistant material like canvas, nylon or vinyl-coated fabric;
3. Each exhibition banner is limited to a maximum sign area of 200 square feet;
4. Exhibition banners must be securely and tautly attached to the wall of the structure and no exhibition banner may be located higher than the roofline;

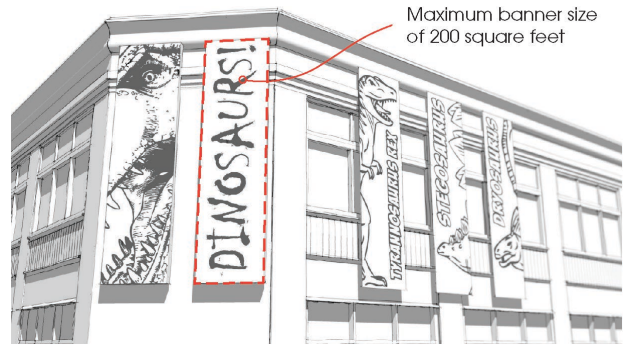

E. Billboard.

The following types of signs require a zoning permit before they can be erected on a site;

1. Billboards are permitted as indicated in Table 50-27-4 subject to the following regulations. However, billboards are only permitted in the MU-B and I-G districts with the use of an exception credit (Section 50-38.7). Billboards are also further restricted by the requirements of Minnesota State Statute Section 173.08, Subdivision 2, as amended from time to time;
2. The maximum sign area for a billboard is 700 square feet;
3. Billboards adjacent to on-grade roadways are limited to a maximum height of 25 feet. Billboards adjacent to grade separated/elevated roadways are permitted to measure the 25 foot height from the roadbed crown to the tallest projection of the structure. This measurement is taken at a perpendicular angle between the grade separated/elevated roadway and the sign location;
4. Billboards may only be mounted as freestanding pole signs. However, when an exception credit is used, billboards may be wall-mounted and are limited to the wall sign area allowed for that district;

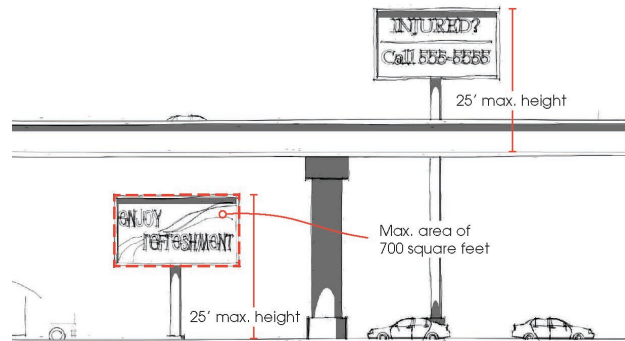

5. Billboards are required to be spaced 500 feet apart, subject to the following:
- Billboards located along Interstate Highway No. 35 and Interstate Highway No. 535 must be spaced 800 feet apart, unless erected under an exception credit in which case only the 500 foot spacing is required;
 - Spacing is measured along the nearest edge of the right-of-way pavement to which the billboard is displayed and between points directly opposite the center of the billboard;
 - Spacing requirements apply only to billboards located on the same side of the same highway.
 - Multi-faced or back-to-back billboards, up to a maximum of a five foot separation between sign faces, are considered one billboard;

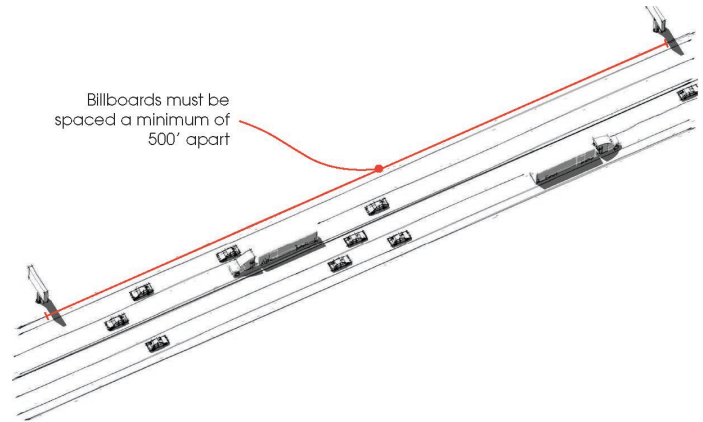

6. Electronic billboards are permitted only in the MU-C, MU-B, and I-G districts. Electronic billboards are subject to the following regulations:
- An electronic billboard may only be erected if one of the following criteria is met:
 - The electronic billboard is constructed using exception credits. The number of exception credits, in square footage, must equal three times the square footage of the electronic billboard to be constructed;
 - Nonconforming billboards of a total square footage are removed in an amount equal to three times the square footage of the electronic billboard to be constructed;
 - Each message displayed on an electronic billboard must be static or depicted for a minimum of eight seconds. Any scrolling, flashing or movement of the message is prohibited;
 - The maximum brightness of an electronic billboard is limited to 5,000 nits or 464 candelas per square foot during daylight hours, and 500 nits or 46 candelas per square foot between dusk to dawn. The billboard must have an automatic dimmer control that produces a distinct illumination change from a higher allowed illumination level to a lower allowed level for the time period between one-half hour before sunset and one-half hour after sunrise;
7. No off-premises sign or billboard in excess of 60 square feet shall be erected or maintained in any area shown on the maps in Exhibit 50-27.8-1;

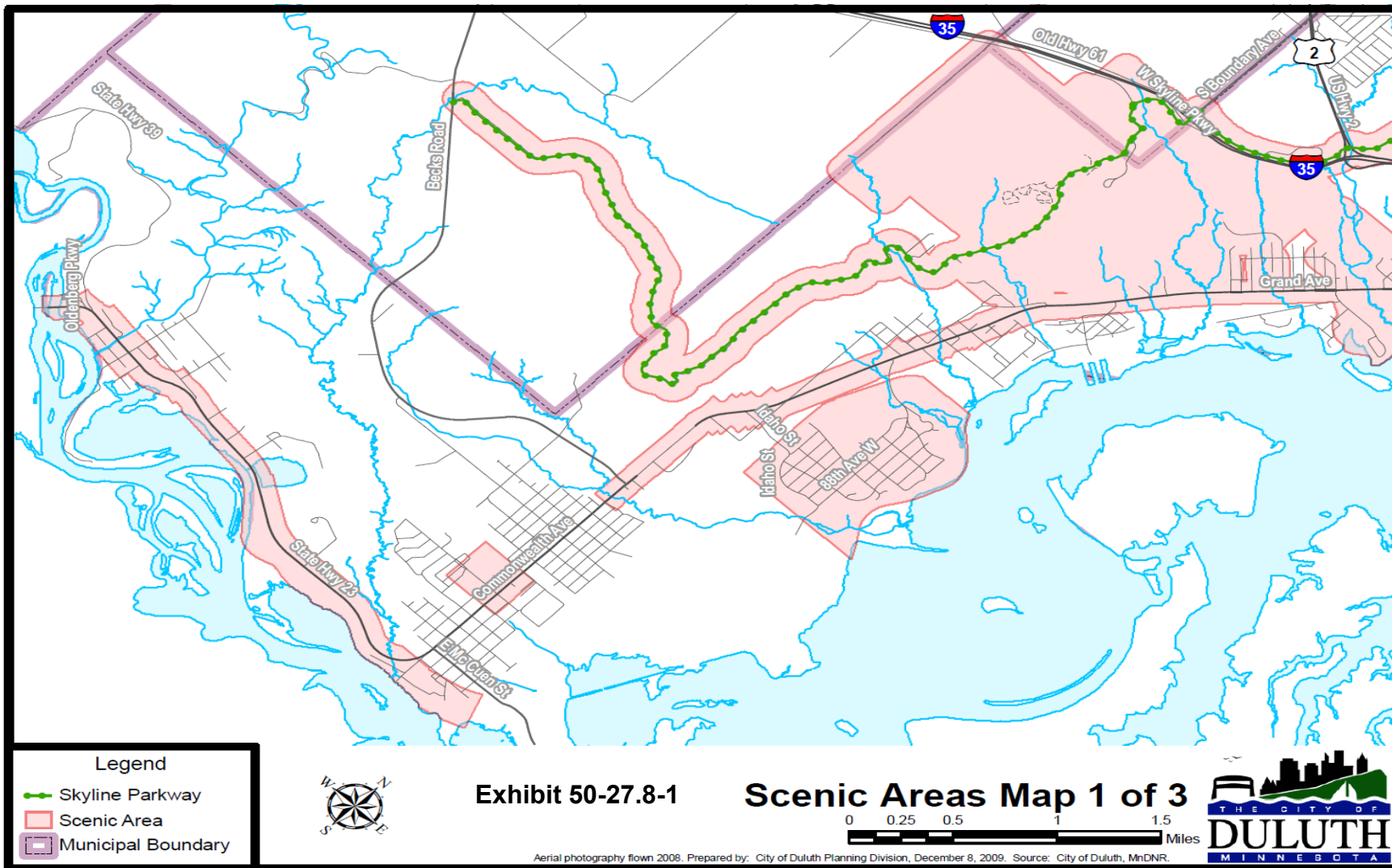

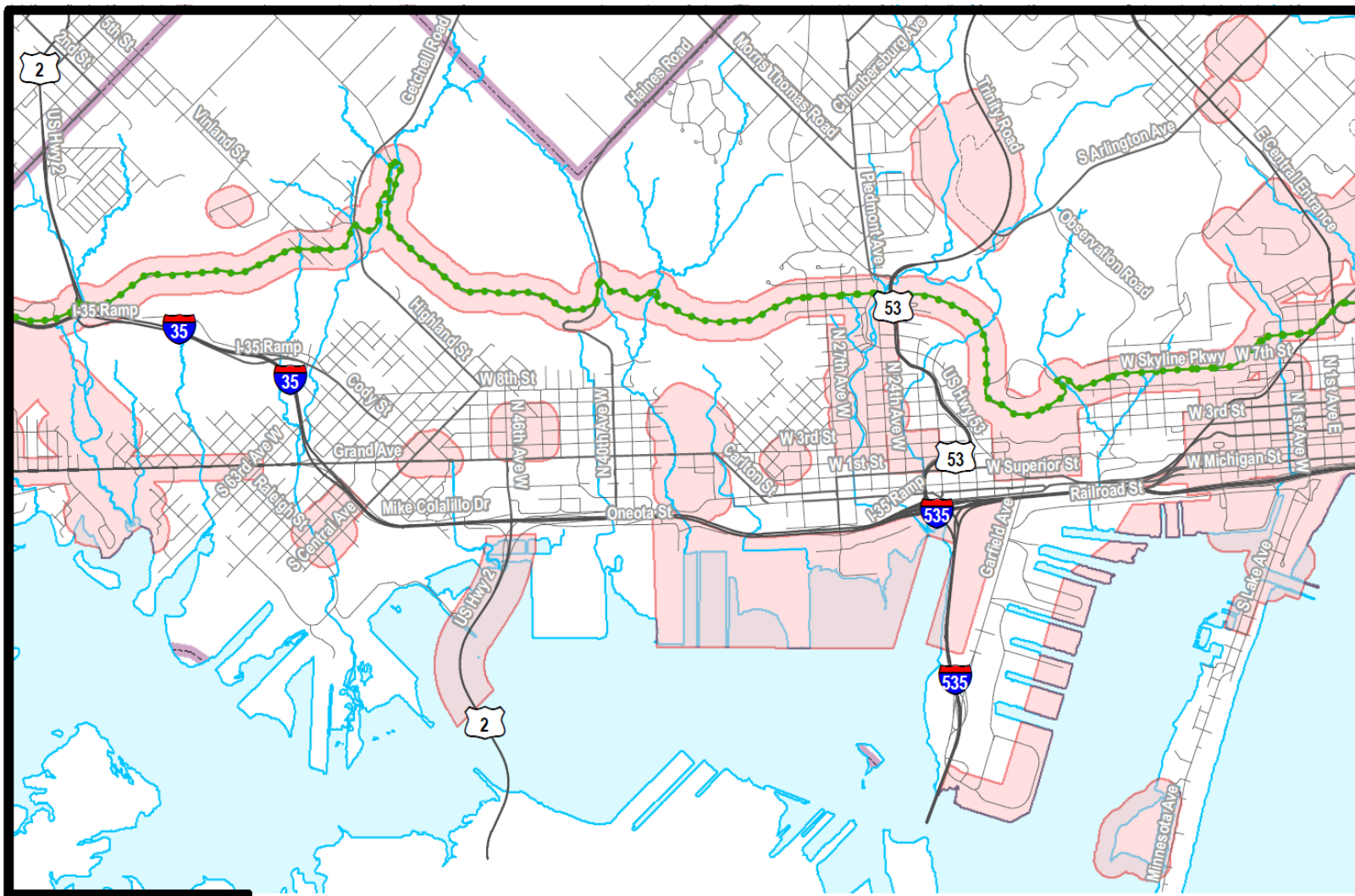

Legend

- Skyline Parkway
- Scenic Area
- Municipal Boundary

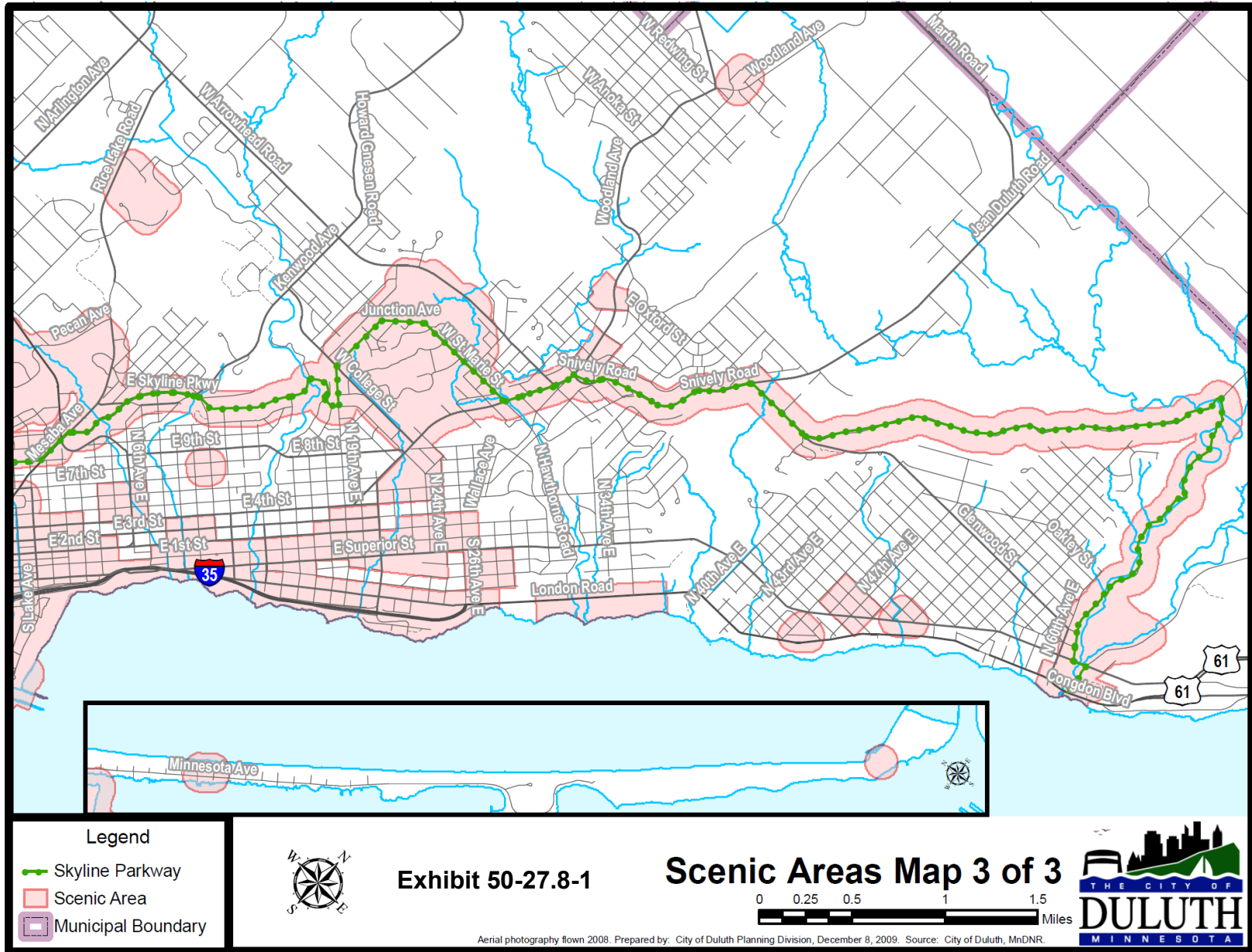

Exhibit 50-27.8-1

Scenic Areas Map 2 of 3



Aerial photography flown 2008. Prepared by: City of Duluth Planning Division, December 8, 2009. Source: City of Duluth, MnDNR.



F. Canopy.

Canopies without printing, with the exception of a street address number (number only), are considered an architectural feature and are not regulated by this Section. This Section regulates canopy signs, which are used to identify a use by name or logo, the goods or services offered on-site, and similar sign information. Canopy signs are permitted as indicated in Table 50-27-4 subject to the following regulations:

1. Canopy signs must maintain a minimum vertical clearance of seven feet six inches (7' 6");
2. Canopy signs must be located at least 18 inches from the back of curb. Support posts must maintain a minimum separation of five feet between posts and between the posts and any building wall. No obstructions are permitted within this area;
3. Canopy signs must comply with Minnesota State Building and Fire codes, including provisions for encroachment into the public right-of-way, structural requirements, sprinkler protections and similar regulations;
4. Canopy signs must be made of a durable, weather-resistant material like canvas, canvas-like material, nylon, vinyl-coated fabric or metal. Solid, flat-roofed canopies may also be made out of finished wood, wood and plastic composites, metal or metal cladding, stucco or EIFS;
5. Printing on any canopy sign is limited to 30 percent of the surface area. Signs mounted to solid, flat roofed canopy are limited to individually-mounted letters with internal illumination (if illuminated) or a sign board with external illumination – no internally illuminated cabinet signs;
6. Canopies may include underside, external illumination;
7. Under-canopy signs are permitted subject to the following:
 - (a) Under-canopy signs must be attached to the underside of a canopy. Under-canopy signs must not project beyond the canopy;
 - (b) Under-awning signs must maintain a minimum vertical clearance of seven feet;
 - (c) A maximum of one under-canopy sign is permitted;
 - (d) Each under-canopy sign is limited to a maximum of six square feet;
 - (e) Under-canopy signs must be securely fixed to the awning with metal supports;
 - (f) Under-awning canopy must be made of wood, metal or plastic;

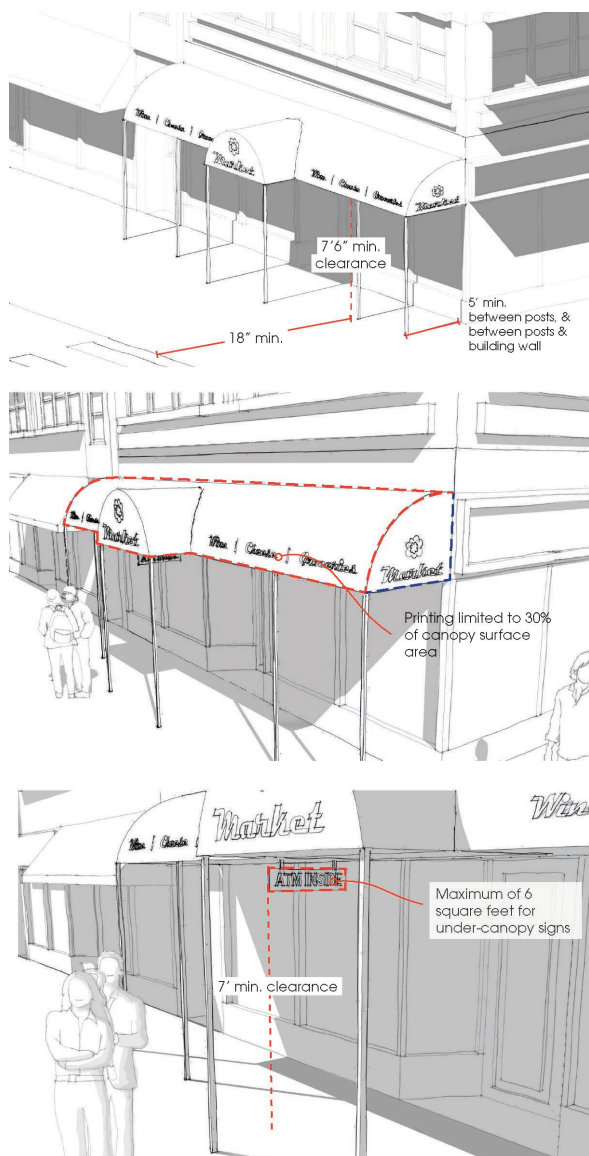

G. Electronic message sign.

Electronic message signs are permitted as indicated in Table 50-27-4 subject to the following regulations. However, all filling stations in any district are permitted to display fuel prices by an electronic message component. Such component must only display numerical fuel prices and must be static.

1. Only one electronic message sign per lot is permitted;
2. Each message or image displayed on an electronic message sign must be static or depicted for a minimum of eight seconds. Any scrolling, flashing or movement of the message is prohibited;
3. The maximum brightness of an electronic message sign is limited to 5,000 nits or 464 candelas per square foot during daylight hours, and 500 nits or 46 candelas per square foot between dusk to dawn. The sign must have an automatic dimmer control that produces a distinct illumination change from a higher allowed illumination level to a lower allowed level for the time period between one-half hour before sunset and one-half hour after sunrise;
4. Electronic message signs are permitted as part of a freestanding sign, wall sign or marquee and, in addition, are subject to the requirements for those sign types;
5. Electronic message signs must be integrated into the larger sign structure and must include the name of the use as a non-electronic component as part of the sign structure. Electronic message signs are limited to a maximum of 60 percent of the sign area of the freestanding or wall sign with which it is integrated;
6. Electronic message signs cannot display any off-premises commercial advertising;
7. Electronic display screens are prohibited;

H. Freestanding signs-pole and monument.

Freestanding signs are permitted as indicated in Table 50-27-4, subject to the following regulations:

1. Freestanding sign maximum height and sign areas are as indicated in Table 50-27-5. Freestanding signs must be constructed of solid or composite finished wood, metal, masonry, neon, glass or nonwoven plastic;
2. Only one freestanding sign, either pole or monument, is permitted per street frontage of a lot. For each additional 200 feet of street frontage, above an initial 200 feet of frontage, an additional freestanding sign, either pole or monument, is permitted, up to a maximum of three freestanding signs;
3. All freestanding signs over seven feet in height must submit construction plans prepared by a design professional licensed in Minnesota that comply with the requirements of the Minnesota State Building Code;
4. No part of a freestanding sign may project into, over or otherwise encroach on a public right-of-way;
5. A freestanding pole sign must maintain a minimum vertical clearance of eight feet. When the pole structure of a freestanding pole sign is wrapped in any decorative material, the decorative pole wrapping must be permanently installed. Decorative wrapping shall not be closer than three feet to the property line, and shall not be wider than 25 percent of the sign face. No temporary signs may be attached to the pole of a freestanding pole sign;
6. Freestanding monument signs may be internally or externally illuminated. If externally illuminated, all light must be directed onto the sign face. Freestanding pole signs may only be internally illuminated;

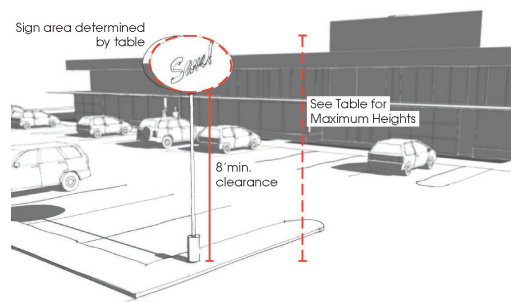
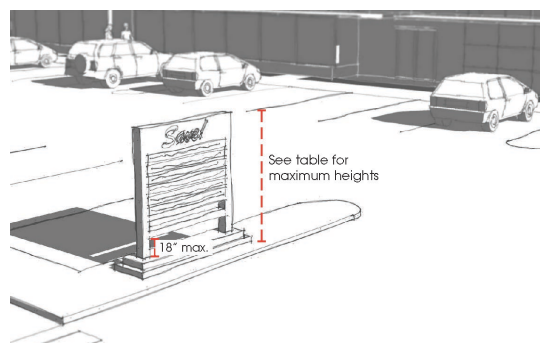

TABLE 50-27-5: FREESTANDING SIGN REGULATIONS			
DISTRICT	SIGN AREA	POLE SIGN	MONUMENT SIGN
	Maximum Sign Area (Square Feet)	Maximum Sign Height (Feet)	Maximum Sign Height (Feet)
R-C	42 sf	17	6
RR-1	42 sf	17	6
RR-2	42 sf	17	6
R-1	42 sf	17	6
R-2	42 sf	17	6
R-P	42 sf	17	6
MU-N	42 sf	17	6
MU-C*	60 sf	25	8
MU-I*	50 sf	25	8
MU-B*	50 sf (Monument)	Prohibited	8
MU-W*	50 sf	20	6
MU-P*	60 sf	25	8
F-1	42 sf	17	6
F-2	42 sf	17	6
F-3	42 sf	17	6
F-4	42 sf	17	6
F-5	42 sf	17	6
F-6	42 sf	17	6
F-7	42 sf	17	6
F-8	42 sf	15	6
F-9	60 sf	25	8
I-G*	60 sf	25	8
I-W*	60 sf	25	8
P-1	42 sf	17	6

*Freestanding Pole and Monuments Signs in the MU-I, MU-B and MU-W zones are allowed a maximum of 50 sq ft. However, for sites with lot frontage that exceeds 250 lineal feet, the maximum size area of the sign may equal up to 20 percent of the lineal street frontage on the street nearest the sign, up to a maximum sign area of 100 sq ft.

*Freestanding Pole and Monument Signs in the MU-C, MU-P, I-G, and I-W zones are allowed a maximum of 60 square feet. However, for sites with lot frontage that exceeds 300 lineal feet, the maximum size area of the sign may equal up to 20 percent of the lineal street frontage on the street nearest the sign, up to a maximum sign area of 150 square feet.

I. Marquee.

Marquees are permitted as indicated in Table 50-27-4, subject to the following regulations:

1. Marquees must be supported solely by the building to which they are attached. No exterior columns or posts are permitted as supports;
2. No marquee may be erected on any building or other structure of wood frame construction;
3. The roof of a marquee may not be used for any purpose other than to form and constitute a roof and must be constructed of noncombustible material;
4. Water from the roofs of a marquee may not drain, drip or flow onto the surface of a public sidewalk. Sufficient downspouts, drains and gutters must be installed as part of each marquee to prevent water from flowing onto the surface of a public sidewalk;
5. Marquees must be erected over a building entrance and are limited to the width of the building entrance. An additional five feet on each side of the entrance doors covered by the marquee is permitted;
6. All marquees must maintain a minimum vertical clearance of eight feet and the roof of the marquee structure must be erected below the second floor window sill. Marquees may encroach up to 18 inches from the back of curb;
7. Marquees are permitted lettering attached to and located above the roof of a marquee to a maximum height of 24 inches;
8. Marquees may be internally illuminated. External Illumination is prohibited;

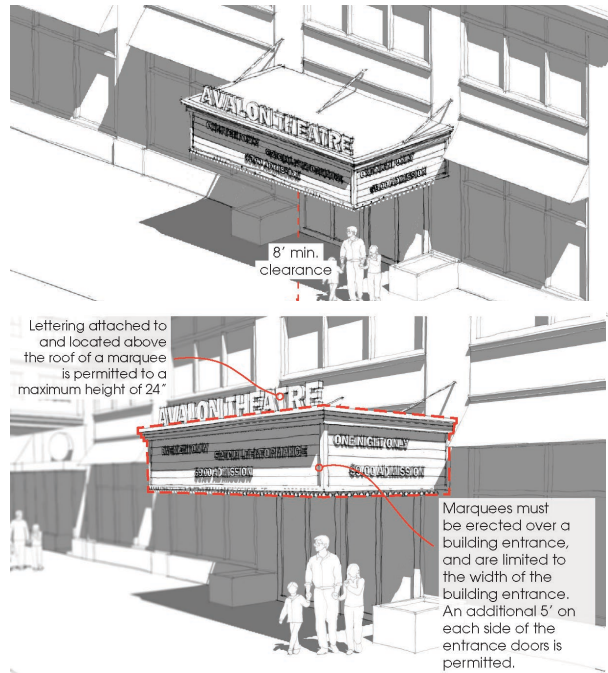

J. Projecting signs.

Projecting signs are permitted as indicated in Table 50-27-4, subject to the following regulations:

1. Projecting sign maximum area is as indicated in Table 50-27-6;
2. One projecting sign is permitted per establishment with frontage on a street. For a corner lot, one projecting sign is permitted for each street frontage. Projecting signs must be above or adjacent to the building entrance or, if a corner lot, the corner of the building;
3. Projecting signs may not project more than six feet from the face of the building to which they are attached, including the area between the sign and the face of the building;
4. Projecting signs must maintain a minimum vertical clearance of eight feet. No projecting sign affixed to a building may project higher than the building height, including the sign support structure;
5. Projecting signs, including frames, braces, and supports, must be designed by a licensed structural engineer or manufacturer. No projecting sign may be secured with wire, chains, strips of wood or nails nor may any projecting sign be hung or secured to any other sign. Any movable part of a projecting sign, such as the cover of a service opening, must be securely fastened by chains or hinges;
6. Projecting signs must be constructed of wood, metal, durable, weather-resistant material like canvas, canvas-like material, nylon or vinyl-coated fabric, or plastic. Projecting signs constructed of material must be mounted so that they are held taut between support posts;
7. Projecting signs may be internally or externally illuminated. If externally illuminated, all lighting must be directed onto the sign face from above;
8. Maximum projecting sign areas are provided in Table 50-27-6: *Projecting Sign Regulations*;
9. Projecting signs erected on properties within the Entertainment District and Historical Canal Park are subject to additional requirements as provided in 50-27.8;

TABLE 50-27-6: PROJECTING SIGN REGULATIONS	
DISTRICT	MAXIMUM AREA
R-C	Prohibited
RR-1	Prohibited
RR-2	Prohibited
R-1	Prohibited
R-2	Prohibited
R-P	Prohibited
MU-N	36 sf
MU-C	48 sf
MU-I	48 sf
MU-B	48 sf
MU-W	36 sf
MU-P	48 sf
F-1	36 sf
F-2	36 sf
F-3	36 sf
F-4	36 sf
F-5	36 sf
F-6	36 sf
F-7	36 sf
F-8	48 sf
F-9	48 sf
I-G	48 sf
I-W	48 sf
P-1	Prohibited

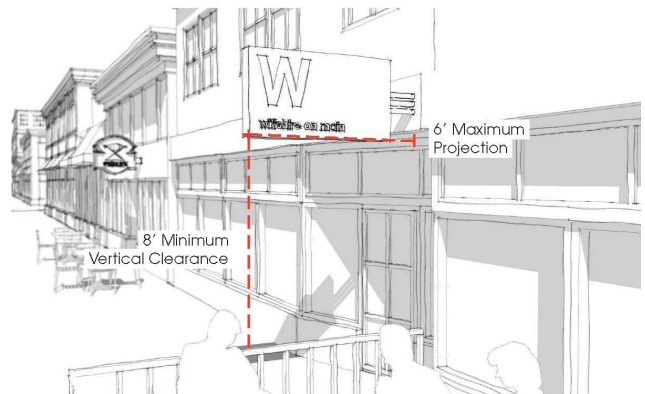

K. Scoreboard and outfield signs.

1. Scoreboards and outfield signs are permitted as indicated in Table 50-27-4, subject to the following regulations. Such signs are further restricted to recreational playing fields only;
2. Scoreboards must be constructed as a freestanding pole sign, no more than 300 square feet in sign area and 25 feet in height;
3. The score-keeping portion of the scoreboard may utilize an electronic message component;
4. If the scoreboard cannot be viewed from any adjacent right-of-way as measured along 500 foot sight lines from the scoreboard, up to 30 percent of the sign area may be used for off-premises advertising. If the scoreboard can be viewed from any adjacent right-of-way, up to 25 percent of the sign area may be used for off-premises advertising;
5. There is no limit on the number of outfield advertising signs so long as no such signs are visible from an adjacent right-of-way. No permit is required for outfield advertising signs;
6. Scoreboards and outfield signs that are part of a sports stadium as a principal use are considered part of the structure and not subject to these standards;

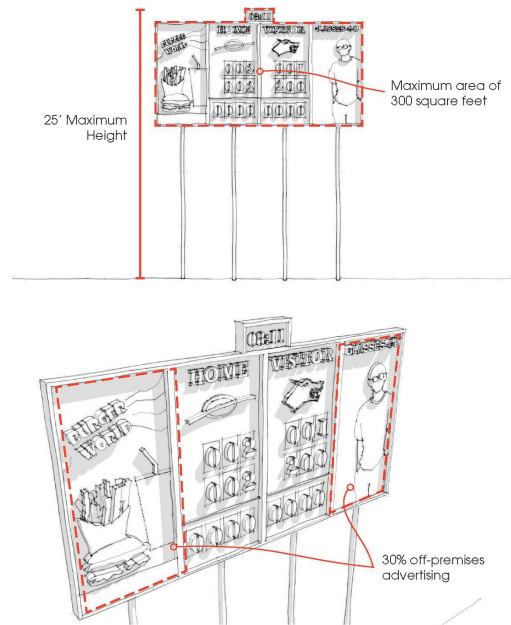

L. Wall signs.

Wall signs are permitted as indicated in Table 50-27-4, subject to the following regulations.

1. The maximum size of a wall sign is established at two square feet per linear foot of building façade where the wall sign will be mounted or 40 square feet, whichever is greater;
2. In addition, any structure over seven stories in height is permitted one additional wall sign per façade to identify the building, that must be placed within the top 20 feet of the structure and cannot cover any fenestration or architectural features. The maximum size is established at two square feet per linear foot of building façade, measured at the roof line, where the wall sign will be mounted;
3. Wall signs may be internally or externally illuminated. If externally illuminated, all light must be directed onto the sign face from above;
4. Wall signs must be safely and securely attached to the building wall. Wall signs must be affixed flat against the wall and must not project more than 18 inches from the building wall;
5. If a wall sign projects more than two inches from the surface, a minimum vertical clearance of eight feet is required;
6. No wall sign mounted on a structure may project above the roof of the structure to which it is attached, including the sign support structure. Wall signs may be mounted on a parapet wall when such parapet is consistent with the architectural design of the structure and/or the larger development, and such parapet wall is constructed of the same primary building materials as the structure, excluding any accent materials. When attached to a parapet wall, wall signs may not project more than eight feet above the roof of the structure, or 15 feet above the roof of the structure on properties zoned MU-C;

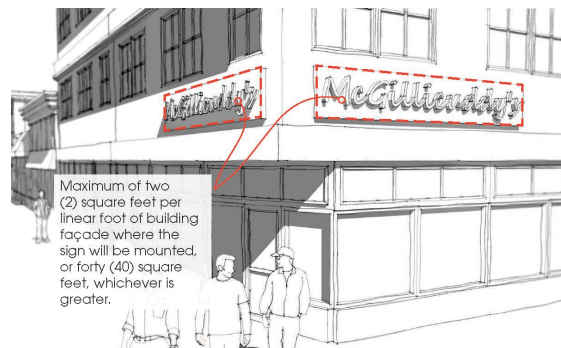

7. Wall signs must be constructed of wood, brick, metal or plastic. Wall signs of durable, weather-resistant material like canvas, canvas-like material, nylon or vinyl-coated fabric are also permitted but the signs must be held taught to the building with no sags or wrinkles and the mounting devices must be concealed by a frame that covers the entire perimeter of the banner;
8. Wall signs must not cover windows, doors or architectural features. However, wall signs are permitted on architectural appurtenances, such as chimneys or penthouses, which are part of the original structure;
9. Ghost signs are considered wall signs. Existing ghost signs are exempt from these requirements and deemed conforming. Ghost signs may be maintained and repainted but no new information or images may be added to the existing sign. No new wall signs may be painted over ghost signs. (Ord. No. 10044, 8-16-2010, § 6; Ord. No. 10204, 3-11-2013, § 1; Ord. No. 10222, 5-13-2013, § 1; Ord. No. 10286, 3-10-2014, § 15; Ord. No. 10338, 11-24-2-14, § 3.)



50-27.8 Areas of special sign control.

A. Purpose.

The city recognizes that certain areas present a unique character that could be strengthened and enhanced with the application of specific sign standards. These commercial areas are:

1. Entertainment districts:
 - (a) Lake Avenue South from Railroad Street to lift bridge;
 - (b) East Superior Street from Lake Avenue to 9th Avenue East;
2. Historic Canal Park: Canal Park Drive from Lake Place Drive to canal;

B. Entertainment district standards.

1. All projecting signs are permitted a maximum sign area of 36 square feet, unless the zoning district allows a greater maximum sign area;
2. Marquee signs are permitted;
3. Electronic message signs are permitted as components of wall, marquee or freestanding signs, subject to the electronic message sign regulations;

C. Historical Canal Park standards.

1. All projecting signs are limited to a maximum sign area of 12 square feet;
2. All projecting signs may only be externally illuminated from above;
3. All signs must be constructed of wood, brick or metal. Individually mounted plastic letters are permitted for wall signs if wholly covered with opaque paint;
4. All signs are limited to colors from the following color palette. Photographs of the color palette swatches are provided for illustrative purposes only. Applicants may view the original palette at the city of Duluth. For the purposes of this ordinance, the specific colors are provided in two types. The first describes the paint colors originally cited in the DWMX District, which are a series of Ace Hardware paint colors. A general Pantone equivalent is also provided, which are the "uncoated" Pantone PMS colors. Pantone is a color system used in a variety of industries, primarily printing, and occasionally in the manufacture of colored paint, fabric, and plastics. Applicants may consult with the land use supervisor to determine the final colors to be used in the sign, which must meet the general color requirements of this Section.

(Ord. No. 10044, 8-16-2010, § 6; Ord. No. 10204, 3-11-2-13, § 1; cited only in Ord. No. 10222, 5-13-2013, § 1.)

COLOR PALETTE

Ace Hardware Paint Color	General Pantone Color (Uncoated) Equivalent	Ace Hardware Paint Color	General Pantone Color (Uncoated) Equivalent
	Far Horizon 65A-2P 649		Mirage Lake 65A-3P 650
	Cocoa Parfait 25C-1P 4755		Malibu Sand 25B-2T 466
	Tuxedo Gray 78C-1P 650		Gray Tweed 78C-3D 5425
	Gray Duck 73C-2P 651		Symphony Blue 73C-4D 5415
	Bobby Blue 66B-2T 637		Black Magic 65A-1A Process Black
	Riviera Sky 75B-3D 646		Spectrum Blue 67B-4D 3005
	Tahiti Blue 58C-2T 630		Calico Blue 75A-1A 2955
	Green Stone 60C-2T 623		Nanking Blue 66B-4D 313
	Sea Vista 56C-2T 629		Veridiam 60C-4D 371
	Aqua Pool 56C-3D 326		Gemstone 56C-4D 3292
Ace Hardware Paint Color	General Pantone Color (Uncoated) Equivalent	Ace Hardware Paint Color	General Pantone Color (Uncoated) Equivalent
	Cane 36B-1T 726		Harvest 36B-2D 727
	Peach Velvet 15B-2T 699		Dawn Sun 15B-3D 708
	Coral Reef 7B-2T 701		Spectrum Red 5A-1A 186
	Pagoda Red 5C-4D 703		War Dance 14A-1A 188
	Blushing Pink 4C-2T 673		Rosalind 4C-4D 207
	Tarragon 25C-3D 465		Stratum Rock 38A-1A 462
	Lobster Bisque 16C-1P 699		Tile Tan 16C-3D 486
	Ripe Peach 22C-2T 722		Bright Sienna 22C-4D 723
	Tile Tan 16C-3D 486		Really Rust 22A-1A 484
	Bracken Brown 25C-2T 406		Tobacco Gold 47A-1A 4495

50-27.9 Master sign plan.

- A. Following the effective date of this Section, an applicant is required to submit a master sign plan for any new commercial multi-tenant building or development that includes non-residential uses, including mixed-use development, for review and approval by the planning commission. The planning commission shall review the application, conduct a public hearing pursuant to Section 50-37.1.I, with public notice as required by Section 50-37.1.H, and make a decision to adopt, adopt with modifications, or deny the application;
- B. The master sign plan must provide a coordinated design for all building-mounted signs including, at a minimum, criteria and specifications for sign locations, general range of sign area, and lighting. All freestanding signs must be shown on the sign plan, including size, location and lighting;
- C. Once approved, signs erected within the multi-tenant development must follow the master sign plan;
- D. The review and approval process for a master sign plan does not allow for variations to the requirements of this Section. (Ord. No. 10204, 3-11-2013, § 1; cited only in Ord. No. 10222, 5-13-2013, § 1.)

50-27.10 Campus sign plan.

- A. The city recognizes that university or college or hospital campuses have unique sign needs that may need to depart from the requirements of this Section. In such cases, the planning commission may recommend and city council may approve such sign standards for temporary and permanent signs through the review and adoption of a campus sign plan;
- B. A campus sign plan may be applied for by a university or college or hospital campus a minimum of two acres in size. In calculating the area, the entire area does not have to be contiguous and may be separated by public rights-of-way or by individual parcels not owned by the institution. However, the entire area must function as a connected campus;
- C. As part of the establishment of a campus sign plan, a comprehensive sign plan must be submitted. The comprehensive sign plan must describe the sign standards for the campus, including all exceptions to the requirements of this Section. A campus sign plan may be more permissive than the standards of this section. Directional signs within the campus may be described generally by sign area and height and general locations;
- D. The planning commission shall review the application, conduct a public hearing pursuant to Section 50-37.1.I, with public notice as required by Section 50-37.1.H, and make a decision to adopt, adopt with modifications, or deny the application;
- E. Alternately, a campus sign plan may be incorporated into the review and approval process of the district plan option of the MU-I District. (Ord. No. 10204, 3-11-2-13, § 1; cited only in Ord. No. 10222, 5-13-2013, § 1.)

50-27.11 Classic signs.

A. Purpose.

Because the city recognizes that certain existing signs do not conform with this Chapter but are particularly unique and/or have historic value, including signs for products or businesses that are no longer located on-site, the classic sign designation is established where the city can designate certain signs as classic signs. Once designated, the classic sign is deemed conforming, and thus is no longer nonconforming, provided the sign is maintained in good condition and its physical integrity remains intact. Any sign designated on the national historic register is automatically considered a classic sign under this Section;

B. Eligibility.

1. An owner of a sign, or the city may apply for designation of an existing sign as a classic sign. Classic signs are exempt from area, setback, height, lighting, movement, placement, type, content, and construction materials requirements of this Section;
2. To qualify for designation as a classic sign, the sign must:
 - (a) Be at least 25 years old or an exact replica of an original sign where the combined age of the duplicate and original sign is at least 25 years;
 - (b) Possess unique physical design characteristics, such as configuration, message, color, texture, etc.;
 - (c) Be of significance to the city, regardless of the use identified by the sign;
3. A sign designated a classic sign may remain on the premises even if the original use to which the sign relates is no longer located on the premises. A designated classic sign may also be moved to a new structure;

C. Application.

The application for classic sign status must be made to the land use supervisor, who will schedule a public hearing. The planning commission may approve or deny the application;

D. Maintenance.

The owner of a classic sign must ensure that the sign is not structurally dangerous, a fire hazard, an electrical shock hazard, or any other kind of hazard. Classic signs may be rebuilt if damaged;

E. Designated classic signs.

A list of designated classic signs is maintained by the land use supervisor. (Ord. No. 10204, 3-11-2013, § 1; cited only in Ord. No. 10222, 5-13-2013, § 1.)

50-27.12 Master mass transit shelter sign plan.

- A. Following the effective date of this Section, a master mass transit shelter sign plan is required for any signage, other than route information, to be placed in or on any mass transit shelter located in a public right of way;
- B. The planning commission shall review the plan, conduct a public hearing pursuant to Section 50-37.1.I, with public notice as required by Section 50-37.1.H, and make a decision to approve, approve with modifications, or deny the application. The plan shall not allow for variations to the requirements of 50-27 with the exception of off-site commercial messaging;
- C. The master sign plan must provide a coordinated design for all signage to be located at or on all transit shelters of the applicant, including, at a minimum, criteria and specifications for sign locations, size of signage, single or double sided signage, lighting, and a maintenance plan for signage;
- D. The master mass transit shelter sign plan shall only apply to transit shelters that are approved by a concurrent use permit;
- E. Signage on a shelter must not exceed one-third of the vertical surface of the shelter, and must not impede the sight triangle as established in 50-25.2;
- F. After the date of this ordinance, mass transit shelters shall be permitted on public right-of-way only pursuant to a concurrent use permit issued pursuant to this chapter, and once the master sign plan has been approved signage erected must be maintained and operated only as provided for in the master mass transit shelter sign plan. (Ord. No. 10743, 4-26-2021§ 1.)